

# TSA 160 NT

## *Swing Door Drive for Automatic Doors*

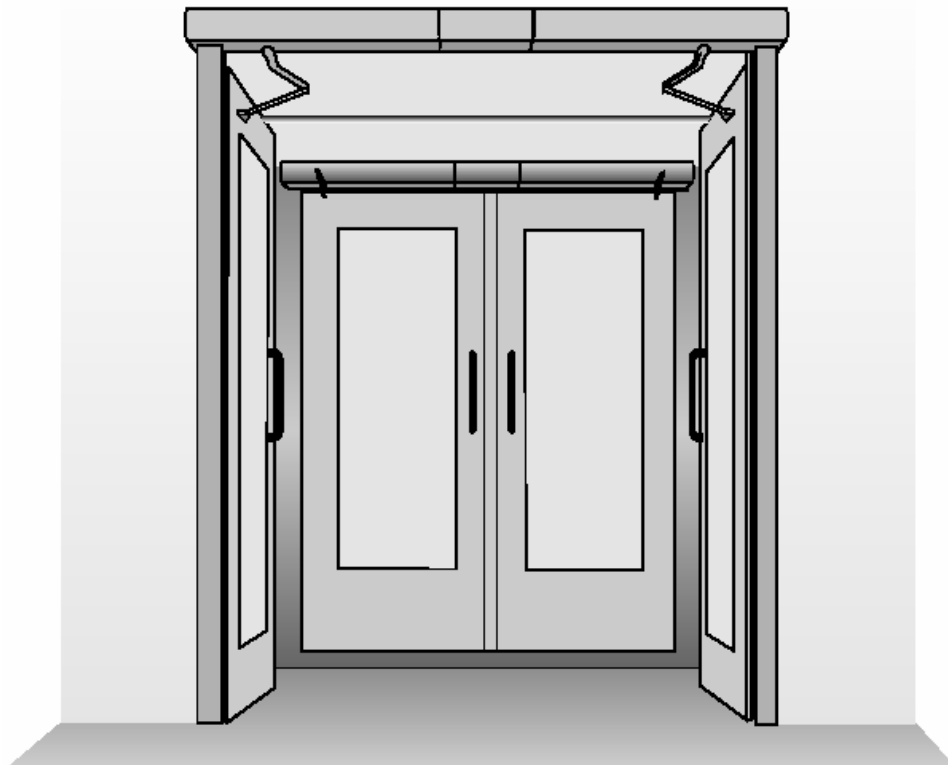

### **Operation & Maintenance Manual**

**GB**

## Contents

<b>Safety Instructions</b>	3
General rules of safety and accident protection.	
<b>System Description</b>	4
Detailed description of drive components	
<b>Occupier Safety Tests</b>	5
Safety check list to be adhered to by the User	
<b>Occupier Safety Test ( continued )</b>	6
Safety check list to be adhered to by the User	
<b>Occupier Safety Test ( continued )</b>	7
Detailed review of control switches.	
<b>Operational Switches ( continued )</b>	8
Detailed review of control switches	
<b>Operational Switches</b>	9
Detailed review of control switches	
<b>General Cleaning &amp; Maintenance</b>	10
Detailed review of cleaning and maintenance procedures.	
<b>Service Information</b>	11
Contact numbers, Warranty & Post Warranty information.	

## Safety Instructions

### General Safety Instructions

Before starting to use the door, read this user manual with care and comply with the following safety instructions at all times:

- The TSA 160 NT automatic swing door operator is only intended for normal usage with automatic doors.
- Please comply with relevant accident prevention regulations.
- Please follow the guidelines for **BS 7036 1996 Safety at Powered Doors for Pedestrian Use**.
- Please adhere to the operating, servicing and repair conditions specified by **GEZE**.
- Servicing and repair work may only be carried out by properly trained **GEZE** personnel or authorized **GEZE** partner.
- Isolate all power before removing cover.
- **IMPORTANT:** The cover may only be removed by properly trained personnel authorized by **GEZE**.
- **GEZE** does not accept responsibility for damage resulting from unauthorized modification of the equipment. Warranty will be void if damage is caused from unauthorized modification.

## System Description

### Drive Unit

The TSA 160 NT is an electronically controlled, hydro-mechanical swing door system for single leaf wood, aluminium and steel doors of either single or double glazed construction.

For double door leaves a TSA 162 Slave unit is fitted in conjunction with the TSA 160 NT.

### Specification

Maximum Leaf Width:		1400mm.
EN size:		EN 3 to EN 6
Maximum Leaf Weight:		250kg
Outside Dimensions of Drive:	W x H x D	690mm x 100mm x 120mm.
Closing position of Door:		Closing pressure by spring action.
Power Supply:		230 V AC, +10%/-14%. 50/60 Hz.
Power Consumption:		200 VA with 230 V AC.

The motor is switched off as soon as the preset open position of the door is reached or upon lapse of the pre-set motor run time.

Motor temperature control by integrated thermostwitch.

Power Failure:		Manual closer function Hydraulically controlled closing
Integrated programme switch (standard)		Position II = Automatic Position I = Permanently Open Position 0 = Off
Supply voltage for peripheral devices		24 V DC, 1200 ma.
Weight of drive		approx 12.5 kg

### Adjustable Functions

Opening speed:		via hydraulic valve.
Closing speed:		within range 75 degrees – 0 degrees.
Opening and closing damping:		via hydraulic valve.
Latching action:		via hydraulic valve.
Closing Force, infinitely:		EN size 3...6
Approach Delay:		0 – 5 seconds.
Adjustable Hold Open Time:		0 – 60 seconds. ( via jumper 0 – 10; 10 – 60 s ).
Door Opening Angle		max. 115 degrees.

### Cover / Intermediate Cover

All necessary connection and ancillary parts are aesthetically covered.

## Occupier Safety Test

### Extract from BS 7036 : Part 2 : 1996 ( Annexes )

This section provides a checklist for occupier safety tests on powered swing doors, which suit the majority of installations. However, the person / organization responsible for the operation and maintenance of the doors should consider each individual installation and adopt a safety test procedure that is suitable for that installation. Additional tests to those given in this section may be necessary if specified by the manufacturer.

### Occupier safety check list for all types of powered swing doors

The occupier is responsible for undertaking the following test procedure which should be carried out at least weekly unless a different frequency for tests is identified in the Hazard Analysis and Risk Assessment ( See 4.6.2.1 of Part 1 ).

For safety reasons it should not be assumed that equipment is working safely. There should be no notice boards, literature racks, merchandise displays, or other distractions or obstructions in the vicinity of the door that may congest or inhibit the traffic flow.

If a fault is found which affects the safe operation of the door, the door operating equipment should be switched off and the door made safe. Use of the door should not be re-instated until an authorized technician has undertaken repairs.

### Automatic Activation Devices

Sensor Activation ( if fitted )

- 1) Test sensor activation as follows.
  - a) For a door opening away from the user, test sensor by walking towards the door opening. The door should start to open when a person is approximately 1400mm ( 5 ft ) from the door. The door should swing smoothly to the open position and stop without impact.
  - b) For a door opening towards the user, the door should start to open when a person is approximately 1400mm plus the width of the door leaf from the door.
- 2) Step out of the activation zone. After a delay ( normally 1s to 5s ) the door should close smoothly.
- 3) Repeat 1 and 2 on the other side of the door opening if the door has two way operation.

Control Mat Activation ( if fitted )

- 4) Test control mat by stepping onto it. The door should swing smoothly to the open position and stop without impact.
- 5) Step off the mat. After a time delay ( normally 1s to 5s ) the door should close smoothly.
- 6) Repeat 4 and 5 on the other side of the opening if the door has two way operation.
- 7) Inspect the mat molding and threshold. The mat should be complete and secured and should not give rise to tripping hazards.

## Occupier Safety Test ( cont`d )

- 8) Various devices are available to protect the threshold area of swing by preventing a door from opening or closing whilst the area is occupied. These include presence-sensing devices and safety mats. Test these devices as follows:
- a) Presence Sensing Safety Devices. If presence sensing devices are fitted proceed as follows.
    - 1) With the door in the closed position, place the test object ( see 8.4.2 of Part 1 ) in the swept area of the doors. Activate the door and verify that either the door starts to open but stops before striking the test object ( see note 1 below ), or that the door does not open at all ( see note 2 below ).
    - 2) Activate the door to the open position. Place the test object as in 1) above and check that either the door starts to close but stops before striking the object ( see note 1 below ), or remains in the fully open position ( see note 2 below ).

Note 1. Where a presence sensing device as described in item a) of 5.4 is fitted, door movement may occur from the fully open or fully closed position, but movement should be inhibited at any point in the opening or closing cycle in order to prevent the door striking the test object.

Note 2. Where a presence sensing device as described in item b) of 5.4 is fitted, door movement should only be inhibited in the fully open or fully closed position and not whilst the door is moving.
  - b) Safety Mats. Where safety mats are fitted proceed as follows.
    - 1) With the door closed, step on the safety mat outside the swept area of the door. When a second person activates the door, it should stay closed as long as the first person remains on the safety mat.
    - 2) Step off the mat and activate the door to the open position. Step through the doorway and onto the safety mat and stand for 10 s. The door should remain open .
    - 3) Step off the safety mat. After a time delay ( normally 1 s to 5 s ) the door should close to the fully closed position and stop without impact.

### General Tests

- 9) Check that the door area has no tripping or slipping hazards.
- 10) Check all door panels for broken or cracked glass.
- 11) Check that all doors have signs correctly displayed at recommended viewing heights.
- 12) Check the position and security of associated screens and barriers.
- 13) Check the operation of manual activation, or remote activation if fitted.
- 14) Check for distractions or obstructions in the vicinity of the door.
- 15) Check that finger guards are secure and in good repair.

## Occupier Safety Test ( cont`d )

### **Extract from BS 7036 : Part 1 : 1996 ( 4.6.2.1 Occupier Safety Checks )**

To ensure continued operation of a powered door installation, the installation and its environment should be subjected to systematic operational checks as often as is appropriate to the type of installation and its traffic flow. This should be assessed with reference to the Hazard Analysis and Risk Assessment carried out under 4.1.4, e.g. in high traffic areas such as shops, hospitals and airports, an appropriate rate would be at least once a week using the tests given in parts 2 to 5.

### **Extract from BS 7036 : Part 1 : 1996 ( 8.4.2 Test Object )**

The following test object should be used.

- a) For presence sensing devices, a cardboard box of approximate dimensions 250mm x 150mm x 710mm high ( 10in x 6in x 28in high ) is a suitable test object.
- b) For motion sensing devices, testing is achieved by the tester approaching the door from several directions in turn.

### **Extract from BS 7036 : Part 3 : 1996 ( 5.4 Safety during opening and closing cycle )**

One of the following types of safety devices should be fitted.

Note. The protection level required is determined by the Hazard Analysis and Risk Assessment

- a) Presence sensing device which interrupts the door movement at any point during its opening cycle.
- b) Presence sensing device or safety mat which gives limited protection by preventing a fully open or fully closed door from moving.

Item b should only be considered where the hazard analysis and Risk Assessment indicates the risk is low.

## Operational Switches

### Operation of Settings – 3 position switch

There are two types of programme switch applicable for this type of drive unit. There is an integrated rocker switch fitted to the end cap of the drive unit. This is the standard form of switch.

Alternatively, there is a remotely fitted key operated programme switch, which can be located within close proximity to the door location.

#### Automatic Function (AUT or position II)

Whilst in this mode the door will be activated automatically by the relevant form of sensor fitted i.e. Radar, Push Pad etc.

#### Hold Open (DO or position I)

Whilst in this function the door will be held permanently open.

#### Off (AUS or position 0)

The automated features of the door are switched off and the door will only open manually.

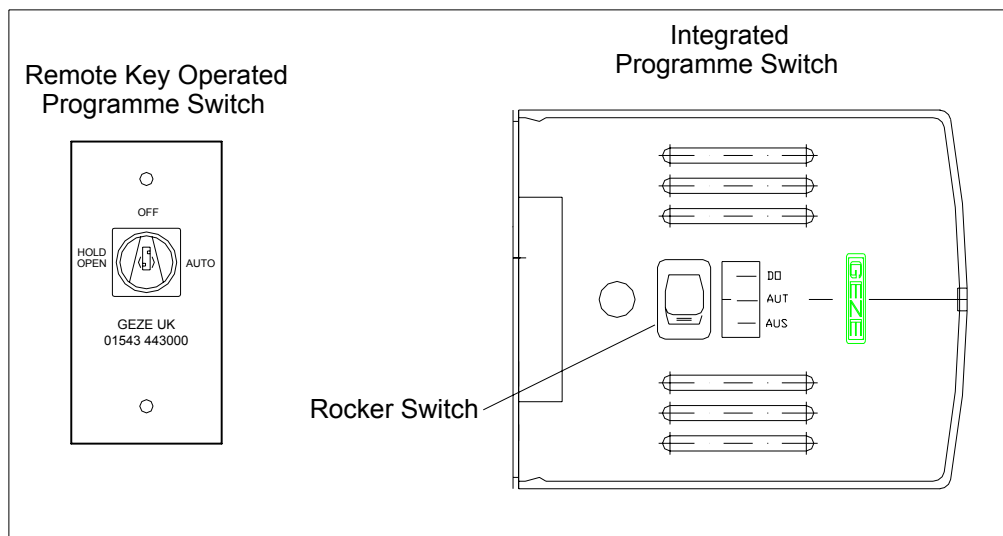

### IMPORTANT NOTICE







If manual locks are fitted to the door leaf, please ensure they are UNLOCKED prior to switching the drive unit on. Also ensure the drive unit is switched off before locking the door.

If the mains power is off, the door can be used manually.

## Operational Switches (cont'd)

### Operation of Settings – Digital Programme Switch (optional)

The optional Digital Programme Switch is located within close proximity to the door location. The DPS allows additional operation modes for the TSA 160 NT and TSA 162 drive units.

Operating mode	Symbol	Descriptions
<b>Automatic</b>  - Summer mode  - Winter mode	  	<b>Door powers open and self closes.</b> The activation devices are active. For double door configurations:  both doors power open when activated.  the master door leaf only, will power open when activated.
<b>Exit only</b>		Only the inner activation device is active.
<b>Permanently open</b>		Door is held in the open position.
<b>Night</b>		The door will only open when the 'out of hours' activation device is activated. Restricted to employees.
<b>On/Off</b>		The door can be opened manually and self close.

### IMPORTANT NOTICE

If manual locks are fitted to the door leaf, please ensure they are UNLOCKED prior to switching the drive unit on. Also ensure the drive unit is switched off before locking the door.

If the mains power is off, the door can be used manually.

## General Cleaning & Maintenance

### Maintenance of Drive Unit

Aluminium Cover

Wipe Clean with a damp cloth. DO NOT allow water to enter through the drive unit cover.

Activation & Safety Sensors

Ensure plastic lenses are clean & dust free. Wipe with a dry soft cloth if necessary.

### Preventative Maintenance

GEZE strongly advise that a preventative maintenance programme is entered into, in line with the recommendations of BS 7036 : Safety at powered doors for Pedestrian Use.

An Authorized Technician to BS 7036 must carry out any servicing.

### Fabricated Doors / Screenwork only - See separate section for electrical drive unit covers.

Atmospheric deposits, sulphurous acids, carbon dioxides and other chemicals in the air will discolour and tarnish all metalwork, and in time cause corrosion. Regular maintenance prevents atmospheric deposits building up and attacking the metals.

### Anodized Aluminium.

Wash with mild soap and water or a mild detergent solution, rinse down with clean water and dry off with a soft cloth or chamois leather. Apply a liquid wax polish to protect the metal from the atmosphere.

AVOID : Metal polish of any kind, abrasive cleaners, strong alkalines or acids, and the use of ammonia based cleaners for washing windows as they can cause staining of the surrounding framework.

Recommended frequency - WEEKLY.

### Polyester Powder Coated Aluminium.

As with any organic coating, in order to retain the aesthetic properties, it is recommended that the coating be regularly maintained. Wash at intervals of not more than three months using a solution of warm water and mild detergent. (e.g. 5 % Teepol solution or mild washing up liquid.) All surfaces should be cleaned using a soft cloth or sponge but nothing harsher than a natural bristle brush.

AVOID : Abrasive cleaners or cleaning solutions such as ketones, esters, or alcohols.

Recommended frequency - THREE MONTHLY (depending on environment.)

### Polished or Satin Stainless Steel.

Wash away grime and grit with luke warm soapy water or a mild detergent solution using a nailbrush for awkward crevices or corners. Repeat with clean water. Dry and polish with a soft duster or chamois leather.

AVOID : Metal polishes, and all abrasives, toxic materials, acids, strong alkalines, nylon pads, wire wool.

Recommended frequency - WEEKLY.

### Glass.

Wash as often as possible with clean water and a chamois leather, scrim or squeegee, and dry off. The occasional application of a proprietary window cleaner or polish can be beneficial providing it does not contain ammonia. Advice may be given by a reputable window cleaning company.

## Service Information

We are committed to the very best in customer service. To ensure rapid response and total peace of mind we offer 24 hour 7 day a week service and repair for all makes of automatic and manual doors throughout the UK.

### Warranty Period - Up to 12 months from installation

Fully comprehensive GEZE parts and labour warranty which covers all faults other than those caused by abuse.

**For Nationwide Assistance call 08456 777781**

### Post - Warranty period

Following the warranty period - GEZE provides a range of Service Contracts to suit individual site requirements. The current BS7036 recommends that powered doors are serviced twice per year - our Service Contracts are therefore based on this important recommendation.

**A comprehensive, 24 hour service,  
nationwide – from your local office...**

#### **GEZE Service *Midlands***

Blenheim Way  
Fradley Park  
Lichfield  
Staffordshire  
WS13 8SY

Tel: 0845 078 0880  
Fax: 0845 078 0881

#### **GEZE Service *South West***

Unit 39, Old Mills Industrial Estate  
Old Mills  
Paulton  
Bristol  
BS39 7SU

Tel: 0845 078 0884  
Fax: 0845 078 0885

#### **GEZE Service *South East***

Unit 15, Farnborough Business Centre  
Eelmoor Road  
Farnborough  
Hampshire  
GU14 7XA

Tel: 0845 078 0878  
Fax: 0845 078 0879

#### **GEZE Service *North***

Unit 24a, Oak Road  
West Chirilton North Industrial Estate  
North Shields  
Tyne & Wear  
NE29 8SF

Tel: 0845 078 0882  
Fax: 0845 078 0883