

ECturn

Translation of the original instructions
GB User manual

GEZE

Contents

1	Symbols and means of representation	3
2	Product liability	3
3	Safety instructions.....	4
4	Terms.....	5
5	Structure	6
6	Operation	7
6.1	Functions	7
6.2	Operating modes	7
6.3	Button programme switch TPS (optional).....	8
7	What to do if ... ?	9
8	Cleaning and maintenance	10
9	Technical data	11

1 Symbols and means of representation

Warnings



In these instructions, warnings are used to warn against material damage and injuries.

- ▶ Always read and observe these warnings.
- ▶ Observe all the measures that are marked with the warning symbol and warning word.

Warning symbol	Warning word	Meaning
	CAUTION	Danger for persons. Non-compliance can result in minor injuries.

Other symbols and means of representation

Important information and technical notes are emphasised in order to illustrate the correct operation.

Symbol	Meaning
	means "important note"
	means "additional information"
▶	Symbol for an action: Here you have to do something. ▶ Observe the sequence if there are several action steps.

2 Product liability

In accordance with the liability of the manufacturer for his products as defined in the German "Produkthaftungsgesetz" (Product Liability Act), the information contained in this brochure (product information and proper use, misuse, product performance, product maintenance, obligations to provide information and instructions) is to be observed. Non-compliance releases the manufacturer from his statutory liability.

3 Safety instructions

Thoroughly read and abide by this user manual before commissioning the door. In addition, always observe the following safety precautions:

- The prescribed mounting, maintenance and repair work must be performed by properly trained personnel authorised by GEZE.
- The country-specific laws and regulations are to be observed during safety-related tests.
- GEZE shall not be liable for injuries or damage resulting from unauthorised modification of the system.
- GEZE shall not be liable if products from other manufacturers are used with GEZE equipment.
- Only original GEZE parts may be used for repair and maintenance work as well.
- The connection to the power supply must be made by a professional electrician. Perform the power connection and safety earth conductor test in accordance with DIN VDE 0100-610.
Exception: If the Ecturn swing door drive is connected to the mains voltage by the mounted power plug, the connection does not have to be carried out by a qualified electrician.
- Use a customer-accessible 10-A automatic circuit-breaker as the line-side disconnecting device.
- Protect the programme switch against unauthorised access.
- If a battery is connected:
 - Check the battery function once a month.
 - Recycle defective batteries.
- If changes are carried out in the detection field of the safety sensors (e.g. objects added or removed): Reteach the drive.
- Observe the latest versions of guidelines, standards and country-specific regulations, in particular:
 - BGR 232 "Guidelines for power-operated windows, doors and gates"
 - DIN 18650 "Building hardware - Powered pedestrian doors"
 - VDE 0100; Part 610 "Erection of low-voltage installations"
 - Accident-prevention regulations, especially BGV A1 "General regulations" and BGV A2 "Electrical systems and equipment".

4 Terms

Term	Statement
Hinge side	That side of the door at which the hinges from which the door leaf is suspended are located. Usually that side of the door located in the opening direction.
Opposite hinge side	That side of the door that lies opposite the hinge side. Usually that side of the door located in the closing direction.
Contactator	Button, switch or motion detector for actuating the door drive. Actuation function in the "Automatic" operating mode. The contactator does not have any function in the "Night"/"Off" operating mode.
Contactator authorised (KB)	Access control function (for example key-operated switch or card reader) used by authorised persons to actuate the door drive. The actuation function is active in the "Automatic" and "Night" operating modes.
Contactator with switch function	Button for opening and closing the door. Actuation function only in the "Automatic" operating mode. The door is opened automatically when the button is first pressed and closed again automatically when the button is pressed the second time. The function can be activated during commissioning by parameter configuration.
Push & Go	When the door is pressed manually out of the closing position during an activated Push & Go function in the "Automatic" operating mode, the door opens automatically as soon as a specific adjustable opening angle is exceeded.
Safety sensor open (SIO)	Presence detector (e.g. active infrared light sensor) for protecting the swinging range of the door in the opening direction. As a rule the sensor is located on the hinge side of the door on the door leaf.
Safety sensor close (SIS)	Presence detector (for example active infrared light sensor) for protecting the swinging range of the door in the closing direction. As a rule the sensor is located on the side opposite the hinge on the door leaf.
Stop	Self-locking switch with which immediate stopping of the door drive can be triggered in case of danger. The drive remains in its current position until the user releases the stop switch again, thus terminating the stop situation.
Electrical door opener	Open-circuit door opener Available as AC or DC door opener version. When the door drive is actuated, the door opener is activated by the control unit of the door drive in as far as the door is in the closing position. The door opener remains activated until the door has left the closing position. Closed-circuit door opener DC door opener version. The door opener is switched off when the door drive is activated, in as far as the door is in the closing position. The door opener remains switched off until the door has left the closing position.
Lock feedback	The lock feedback function is a contact integrated in the door latch that is activated when the door is locked mechanically by the tie bolt of the door lock. It signals to the control unit that the door is locked mechanically and can therefore not be opened by the door drive. In this case the control unit ignores the actuation commands of all the contactors.

5 Structure

System parts and options

- The door drive unit can be mounted in transom mounting at the lintel or in door panel mounting on the door panel.
- The door drive is available as a 1-leaf version.
- The operating elements are arranged differently depending on the situation. For technical reasons, we cannot show all of the possibilities here.

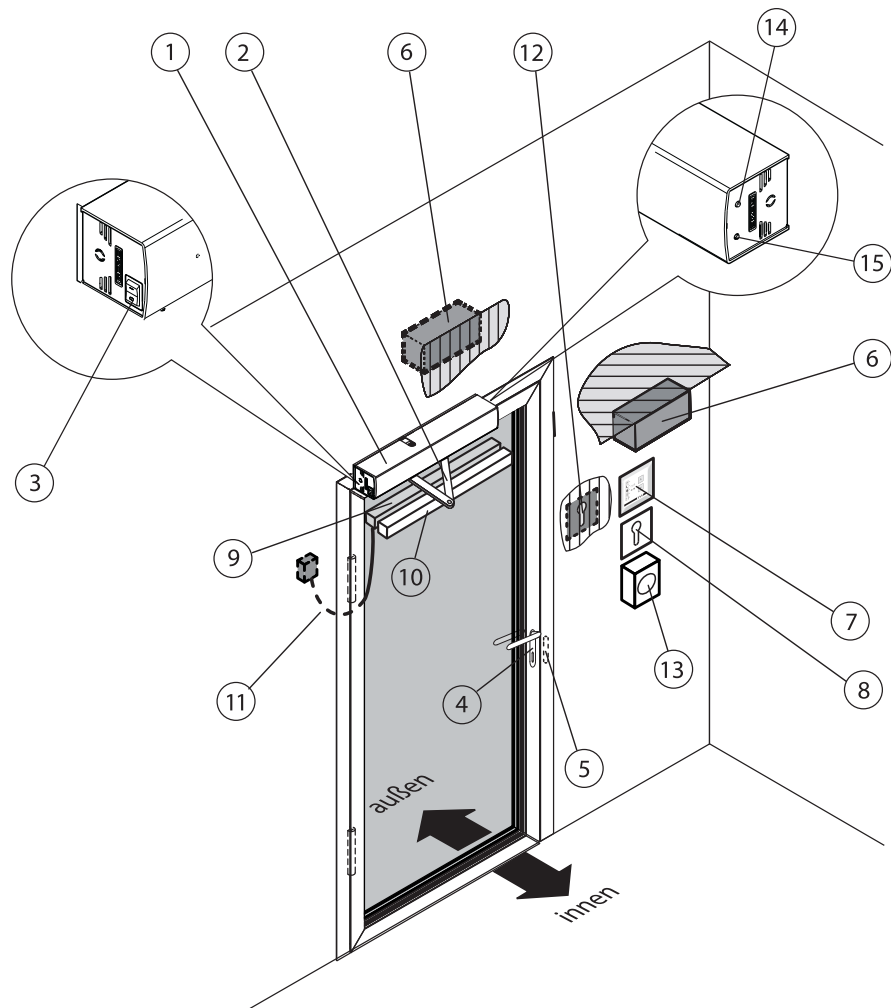

- | | | | |
|---|--|----|----------------------------|
| 1 | Door drive unit | 9 | Safety sensor open (SIO) |
| 2 | Link arm or guide rail | 10 | Safety sensor close (SIS) |
| 3 | Internal programme switch | 11 | Door transition cable |
| 4 | Door handle with door lock | 12 | Contacteur authorised (KB) |
| 5 | Electrical door opener | 13 | Stop switch |
| 6 | Contacteur | 14 | Operating modes switch |
| 7 | Button programme switch | 15 | Operating mode LED |
| 8 | Key-operated switch: Enabling of button programme switch | | |

6 Operation

6.1 Functions

! The set parameters of the drive functions may only be modified by properly trained persons.

i Commissioning and the setting or modification of the door parameters as well as of some special drive functions can be carried out by using the buttons S1, S2 and the 5 LEDs on the controller or with the display programme switch (see wiring diagram Ecturn, ID No. 134079).

6.1.1 Normal operation

In normal door operation, the door is opened and closed automatically.

! **Special cases**
In specific cases (e.g. special wiring, special function settings/parameters, special software) deviations from the information given in this user manual may occur.
▶ If this is the case, please ask the responsible service technician.

Functions in normal operation	Result
A contactor (button, switch or motion detector) is triggered.	Door opens, waits the hold-open time and then closes.
Safety sensor close (SIS) is triggered when the door is open (e.g. light sensor).	Door remains open.
Safety sensor close (SIS) is triggered while the door is closing.	Door reopens immediately.
Safety sensor open (SIO) is triggered while door is opening.	The door stops and remains in the position until the end of actuation (door opens) or until the end of the hold-open time (door closes).
Safety sensor open (SIO) is triggered when the door is closed.	Door remains closed.
A person moves toward the opened door and a motion detector is activated.	Door remains open.
A person moves toward the closing door and a motion detector is activated.	Door reopens immediately.
Door contacts an obstruction when opening.	Door stops, waits and attempts again to move to the open position at a reduced speed. The door then closes again.
Door contacts an obstruction when closing.	Door reopens immediately, waits the hold-open time and then closes at a reduced speed.
Switch/button	Function
Stop switch	The door stops immediately (in every operating mode) and holds the position until the stop switch is unlocked.
Contactor authorised (KB, e.g. outside key-operated switch)	Door opens once and closes after the hold-open time. The set operating mode is retained.

6.1.2 Battery operation in case of power failure

If a battery is installed, the swing door drive remains operational after a power failure for a period of up to 15 minutes (depending on the charging state of the battery and frequency with which the door is used). For setting of the swing door drive with battery operation after a power failure refer to the Ecturn wiring diagram (ID No. 134079).

6.2 Operating modes

Operating mode	Colour
Automatic	Green
Night	Red
Permanently open	Blue
Off	No colour

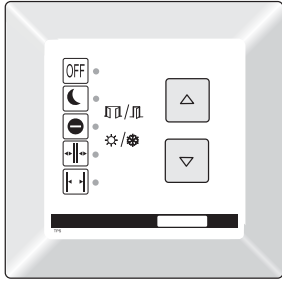

6.3 Button programme switch TPS (optional)

Can be connected additionally to the internal programme switch.



Button programme switch TPS

At the button programme switch, the system operating mode is selected and the corresponding programme is displayed.





The desired operating mode can be selected by pressing the  and  buttons.

The LED of the current operating state lights up.

The shop closing time switch  is not assigned.

The button programme switch is accessible for everyone without a key-operated switch. If desired, an additional key-operated switch can be used for locking. When using a key-operated switch: Enable by operating the key-operated switch once briefly.

Operation of the key programme switch is disabled by briefly re-actuating the key switch.

Operating mode	Switches	Description
Automatic		Door opens and closes automatically. The contactors are active.
Permanently open		Door remains open.
Night		Door opens and closes only when actuated using the key-operated switch.
On / Off		Door is enabled and can be moved by hand.

7 What to do if ... ?

Problem	Cause	Remedy
Door only opens and closes slowly	Obstruction on the sliding path	▶ Remove obstruction and check door leaf for ease of movement.
	Safety sensor close (SIS) soiled	▶ Clean the Safety sensor close.
	Safety sensor close (SIS) misaligned or defective	▶ Notify a service technician.
Door opens and closes constantly	Obstruction on the sliding path	▶ Remove obstruction and check door leaf for ease of movement.
	Light beams or reflections, e.g. reflective floor, falling rain	▶ Check detection field of movement detector
	Misaligned movement detector	▶ Check detection field of movement detector
Door only opens a crack	Obstruction on the sliding path	▶ Remove obstruction and check door leaf for ease of movement.
Door does not open	Obstruction on the sliding path	▶ Remove obstruction and check door leaf for ease of movement.
	Movement detector misaligned or defective (outside)	▶ Check the movement detector. If necessary, notify a service technician.
	Stop activated	▶ Unlock the stop function.
	"Night" operating mode	▶ Select a different operating mode.
	Door locked mechanically	▶ Unlock the door.
	Door opener does not release	▶ Notify a service technician.
	Drive defective	▶ Notify a service technician.
Door does not close	Safety sensor close (SIS) soiled	▶ Clean the Safety sensor close (SIS).
	Safety sensor close (SIS) misaligned or defective	▶ Notify a service technician.
	Obstruction on the sliding path	▶ Remove obstruction and check door leaf for ease of movement.
	Movement detector controls uninterruptedly	▶ Check the movement detector. If necessary, notify a service technician.
	"Permanently open" operating mode	▶ Select a different operating mode.
	Current impulse button function actuates	▶ Terminate actuation by pressing the button once more.
	Operating mode LED flashes red, green or blue	Fault message
Operating mode LED flashes yellow (2x fast)	Initialisation after power failure	▶ Wait for initialisation drive.

8 Cleaning and maintenance



CAUTION!

Danger of injury due to impact and crushing!

- ▶ The mounting, maintenance and repair work must be performed by properly trained personnel authorised by GEZE.
- ▶ Disconnect the drive from the power supply before carrying out work.
- ▶ Unplug the battery plug from the controller before carrying out work.
- ▶ Secure door leaves against accidental movement before carrying out work.
- ▶ Ensure that the drive cannot be activated via radio or Contactor authorised (KB).

Cleaning

Component	Cleaning
Safety sensor close (SIS, e.g. light sensors)	▶ Wipe with a moist cloth.
Glass surfaces	▶ Wipe with a cold vinegar/water mixture; then dry.
Stainless surfaces	▶ Wipe with a non-scratching cloth.
Painted surfaces	▶ Wipe with water and soap.
Anodised surfaces	▶ Wipe with non-alkaline potassium soap (pH value 5.5...7)

Maintenance

The owner must ensure that the system functions properly.

GEZE offers maintenance contracts with the following services:

- Inspect fastening elements for firm seating
- Carry out miscellaneous adjustment work
- Carry out operational checks
- Check all the safety and control equipment of the door system
- Lubricate all the moveable parts
- ▶ If maintenance is required, notify the service technician.

Inspection by trained professionals

In accordance with the "Guidelines for power-operated windows, doors and gates" (BGR 232 and GUV 16.10) Section 6, power-operated doors must be inspected for safety by a trained professional before initial commissioning and at least once a year.

9 Technical data

Opening speed	0 °/s ... 45 °/s
Closing speed	0 °/s ... 45 °/s
Electrical connection values	110 – 230 V; 50 – 60 Hz pursuant to DIN IEC 38
Connected load	max. 300 W Rated voltage 230 V
Fuse protection	Power supply connection 230 V, customer-accessible 10 A
Current draw for external devices	24 V DC connection; max. 600 mA
Temperature range	-15 °C ... +50 °C; for dry rooms only
Enclosure rating	IP 20



We reserve the right to make changes.

We are committed to the very best in customer service. To ensure rapid response and total peace of mind we offer 24 hour 7 day a week service and repair for all makes of automatic and manual doors throughout the UK.

Warranty Period - Up to 12 months from installation

Fully comprehensive GEZE parts and labour warranty which covers all faults other than those caused by abuse.

Post - Warranty period

Following the warranty period - GEZE provides a range of Service Contracts to suit individual site requirements. The current BS7036 recommends that powered doors are serviced twice per year - our Service Contracts are therefore based on this important recommendation.

A comprehensive, 24 hour service,

GEZE Service Midlands

Blenheim Way
Fradley Park
Lichfield
Staffordshire
WS13 8SY

Tel: 0845 078 0880
Fax: 0845 078 0881

GEZE Service North

Unit 24a, Oak Road
West Chirlton North Industrial
Estate
North Shields
Tyne & Wear
NE29 8SF

Tel: 0845 078 0882
Fax: 0845 078 0883

GEZE SCOTLAND

Block 16
Unit 5,
Cambuslang Investment Park
Clydesmill Place
Cambuslang
G32 8RF

Tel: 0845030 9024
Fax: 0845 030 9025

GEZE Service South West

Unit 39, Old Mills Industrial
Estate
Old Mills
Paulton
Bristol
BS39 7SU

Tel: 0845 078 0884
Fax: 0845 078 0885

GEZE Service South East

Unit 15, Farnborough Business
Centre
Eelmoor Road
Farnborough
Hampshire
GU14 7XA

Tel: 0845 078 0878
Fax: 0845 078 0879

Your local office ...

For Nationwide Assistance call 08456 777781

Germany
GEZE Sonderkonstruktionen GmbH
Planken 1
97944 Boxberg-Schweigern
Tel. +49 (0) 7930-9294-0
Fax +49 (0) 7930-9294-10
E-Mail: sk.de@geze.com

Germany
GEZE GmbH
Niederlassung Nord/Ost
Bühningstraße 8
13086 Berlin (Weissensee)
Tel. +49 (0) 30-47 89 90-0
Fax +49 (0) 30-47 89 90-17
E-Mail: berlin.de@geze.com

Germany
GEZE GmbH
Niederlassung West
Nordsterstraße 65
45329 Essen
Tel. +49 (0) 201-83082-0
Fax +49 (0) 201-83082-20
E-Mail: essen.de@geze.com

Germany
GEZE GmbH
Niederlassung Mitte
Adenauerallee 2
61440 Oberursel (b. Frankfurt)
Tel. +49 (0) 6171-63610-0
Fax +49 (0) 6171-63610-1
E-Mail: frankfurt.de@geze.com

Germany
GEZE GmbH
Niederlassung Süd
Reinhold-Vöster-Straße 21-29
71229 Leonberg
Tel. +49 (0) 7152-203-594
Fax +49 (0) 7152-203-438
E-Mail: leonberg.de@geze.com

Germany
GEZE Service GmbH
Reinhold-Vöster-Straße 25
71229 Leonberg
Tel. +49 (0) 7152-9233-0
Fax +49 (0) 7152-9233-60
E-Mail: service-info.de@geze.com

Germany
GEZE Service GmbH
Niederlassung Berlin
Bühningstraße 8
13086 Berlin (Weissensee)
Tel. +49 (0) 30-470217-30
Fax +49 (0) 30-470217-33
E-Mail: service-info.de@geze.com

Austria
GEZE Austria GmbH
Mayrwiesstraße 12
5300 Hallwang b. Salzburg
Tel. +43-(0)662-663142
Fax +43-(0)662-663142-15
E-Mail: austria.at@geze.com

Baltic States
GEZE GmbH Baltic States office
Dzelzavas iela 120 S
1021 Riga
Tel. +371 (0) 67 89 60 35
Fax +371 (0) 67 89 60 36
E-Mail: office-latvia@geze.com

GEZE GmbH
P.O.Box 1363
Reinhold-Vöster-Straße 21–29
71229 Leonberg
Germany

Benelux
GEZE Benelux B.V.
Leemkuil 1
Industrieterrein Kapelbeemd
5626 EA Eindhoven
Tel. +31-(0)40-26290-80
Fax +31-(0)40-26 290-85
E-Mail: benelux.nl@geze.com

Bulgaria
GEZE Bulgaria - Trade
Representative Office
61 Pirinski Prohod, entrance „B“,
4th floor, office 5,
1680 Sofia
Tel. +359 (0) 24 70 43 73
Fax +359 (0) 24 70 62 62
E-Mail: office-bulgaria@geze.com

China
GEZE Industries (Tianjin) Co., Ltd.
Shuangchenzhong Road
Beichen Economic Development
Area (BEDA)
Tianjin 300400, P.R. China
Tel. +86(0)22-26973995-0
Fax +86(0)22-26972702
E-Mail: Sales-info@geze.com.cn

China
GEZE Industries (Tianjin) Co., Ltd.
Branch Office Shanghai
Unit 25N, Cross Region Plaza
No. 899, Ling Ling Road,
XuHui District
200030 Shanghai, P.R. China
Tel. +86 (0)21-523 40 960
Fax +86 (0)21-644 72 007
E-Mail: chinasales@geze.com.cn

China
GEZE Industries (Tianjin) Co., Ltd.
Branch Office Guangzhou
Room 17C3
Everbright Bank Building, No.689
Tian He Bei Road
510630 Guangzhou, P.R. China
Tel. +86(0)20-38731842
Fax +86(0)20-38731834
E-Mail: chinasales@geze.com.cn

China
GEZE Industries (Tianjin) Co., Ltd.
Branch Office Beijing
Rm3A02, Building 3,
ZhuBang 2000 Business Plaza,
No. 98, Balizhuang xili,
Chaoyang District,
100025 Beijing, P.R.China
Tel. +86-(0)10-8797 5177/-78
Fax +86-(0)10-8797 5171
E-Mail: chinasales@geze.com.cn

France
GEZE France S.A.R.L.
ZAC de l'Orme Rond
RN 19
77170 Servon
Tel. +33-(0)1-606260-70
Fax +33-(0)1-606260-71
E-Mail: france.fr@geze.com

Hungary
GEZE Hungary Kft.
Bartók Béla út 105-113.
Budapest
H-1115
Tel. +36 (1) 481 4670
Fax +36 (1) 481 4671
E-Mail: office-hungary@geze.com

Tel.: 0049 7152 203-0
Fax.: 0049 7152 203-310
www.geze.com

Iberia
GEZE Iberia S.R.L.
Pol. Ind. El Pla
C/Comerc, 2-22, Nave 12
08980 Sant Feliu de Llobregat
(Barcelona)
Tel. +34(0)9-02194036
Fax +34(0)9-02194035
E-Mail: info@geze.es

India
GEZE India Private Ltd.
MF2 & 3, Guindy Industrial Estate
Ekkattuthangal
Chennai - 600 097
Tamilnadu
Tel. +91 (0) 44 30 61 69 00
Fax +91 (0) 44 30 61 69 01
E-Mail: office-india@geze.com

Italy
GEZE Italia Srl
Via Giotto, 4
20040 Cambiago (MI)
Tel. +3902950695-11
Fax +3902950695-33
E-Mail: italia.it@geze.com

Italy
GEZE Engineering Roma Srl
Via Lucrezia Romana, 91
00178 Roma
Tel. +3906-7265311
Fax +3906-7265316
E-Mail: roma@geze.biz

Kazakhstan
GEZE Central Asia
050061, Almaty, Kazakhstan
Rayimbek ave. 348, A, office 310
Tel. +7 (0) 72 72 44 78 03
Fax +7 (0) 72 72 44 78 03
E-Mail: office-kazakhstan@geze.com

Poland
GEZE Polska Sp.z o.o.
ul. Annapol 21
03-236 Warszawa
Tel. +48 (0)22 440 4 440
Fax +48 (0)22 440 4 400
E-Mail: geze.pl@geze.com

Romania
GEZE Romania S.R.L.
IRIDE Business Park
Building nr. 10, level 2
Str. Dimitrie Pompei nr. 9–9a
RO-020335 Bucharest, sector 2
Tel. +40 (0) 316 201 257
Fax +40 (0) 316 201 258
E-Mail: office-romania@geze.com

Russian Federation
GEZE GmbH Representative
Office Russia
Kolodesnij pereulok3, str. 25
Office Nr. 5201-5203
107076 Moskau
Tel. +7 (0) 49 55 89 90 52
Fax +7 (0) 49 55 89 90 51
E-Mail: office-russia@geze.com

Scandinavia
GEZE Scandinavia AB
Mallslingan 10
Box 7060
18711 Täby, Sweden
Tel. +46(0)8-7323-400
Fax +46(0)8-7323-499
E-Mail: sverige.se@geze.com

Scandinavia
GEZE Norway
Industriveien 34 B
2072 Dal
Tel. +47(0)639-57200
Fax +47(0)639-57173
E-Mail: norge.se@geze.com

Scandinavia
GEZE Finland
Postbox 20
15871 Hollola
Tel. +358(0)10-4005100
Fax +358(0)10-4005120
E-Mail: finland.se@geze.com

Scandinavia
GEZE Denmark
Høje Taastrup Boulevard 53
2630 Taastrup
Tel. +45(0)46-323324
Fax +45(0)46-323326
E-Mail: danmark.se@geze.com

South Africa
DCLSA Distributors (Pty.) Ltd.
118 Richards Drive, Midrand,
Halfway House Ext. 111
P.O. Box 7934
Midrand 1685
Tel. +27(0)113158286
Fax +27(0)113158261
E-Mail: info@dclsa.co.za

Switzerland
GEZE Schweiz AG
Bodenackerstrasse 79
4657 Dulliken
Tel. +41-(0)62-2855400
Fax +41-(0)62-2855401
E-Mail: schweiz.ch@geze.com

Turkey
GEZE GmbH Türkiye - Istanbul
İrtibat Bürosu
Ataşehir Bulvarı, Ata 2/3
Plaza Kat: 9 D: 84 Ataşehir
Kadıköy / İstanbul
Tel. +90 (0) 21 64 55 43 15
Fax +90 (0) 21 64 55 82 15
E-Mail: office-turkey@geze.com

Ukraine
Repräsentanz GEZE GmbH Ukraine
ul. Vikentiya Hvoyki, 21,
office 151
04080 Kiev
Tel. +38 (0) 44 49 97 725
Fax +38 (0) 44 49 97 725
E-Mail: office-ukraine@geze.com

United Arab Emirates/GCC
GEZE Middle East
P.O. Box 17903
Jebel Ali Free Zone
Dubai
Tel. +971(0)4-8833112
Fax +971(0)4-8833240
E-Mail: geze@emirates.net.ae

United Kingdom
GEZE UK Ltd.
Blenheim Way
Fradley Park
Lichfield
Staffordshire WS13 8SY
Tel. +44(0)1543443000
Fax +44(0)1543443001
E-Mail: info.uk@geze.com



135863-01

GEZE